

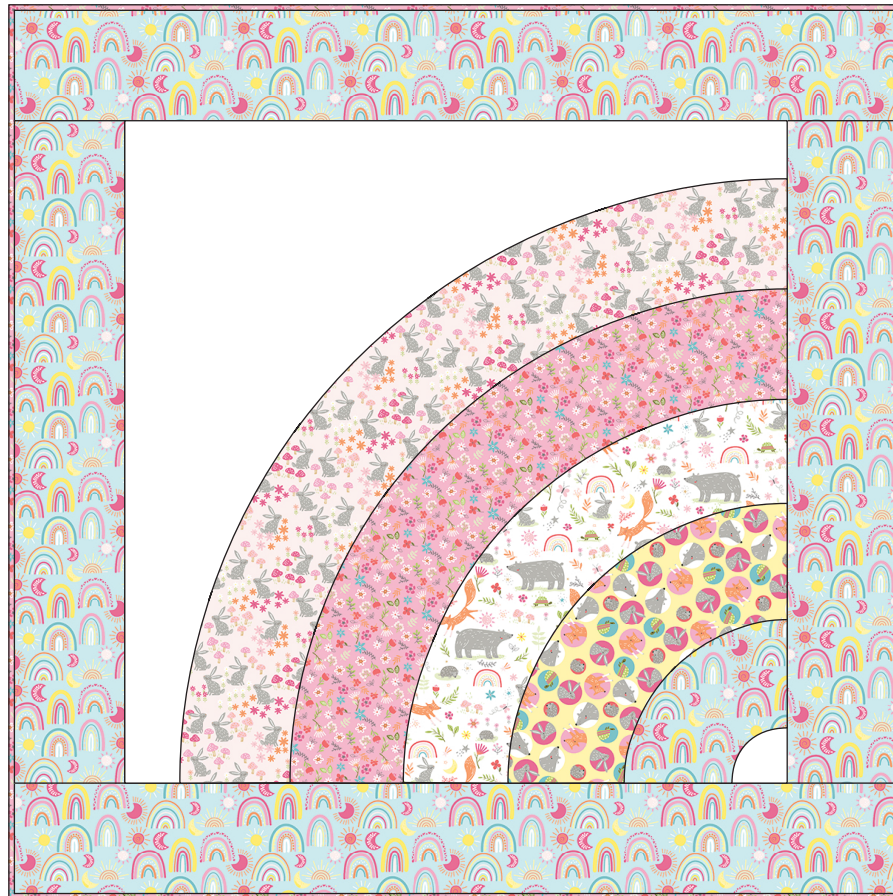

FRIENDSHIP FOREST *by Katie Yost* **Quilt**



Featuring the Friendship Forest Collection by Katie Yost
Shipping to stores July 2022

Finished Size: 40 ½ in x 40 ½ in (102.87 cm x 102.87 cm)

Fabric Needed

3 Wishes® Friendship Forest Collection

- 1 ¼ yds – Rainbows and Sunshine (19191-TRQ-FLN-D)
- 1 ⅞ yds – Flower Garden (19192-PNK-FLN-D) for Piecing and Binding
- 1 yd – Solid White
- 7/8 yd – Bunny Field (19193-PNK-FLN-D)
- 5/8 yd – Friends Forest (19190-WHT-FLN-D)
- ½ yd – Circle Faces (19194-YLW-FLN-D)
- 2 yds – Flower Garden (19192-PNK-FLN-D) for Backing

Additional Supplies Needed:

- 48 in x 48 in (121.92 cm x 121.92 cm) Cotton Batting
- 2 ⅞ yds (194.31 cm) of 17 in wide Fusible web
- Piecing and sewing thread
- Quilting and sewing supplies
- Even-feed foot (optional for quilting)
- Open Toe Foot (optional for Fusible Applique)

Before You Begin

Read all instructions before beginning project. Do not pre-wash fabrics. Press fabrics with a dry iron on cotton setting before cutting. Use a ¼ in (6.35 mm) seam allowance and sew fabrics with right sides together (RST) unless otherwise noted. Press seams in the direction of the arrows. wof = width of fabric

Cutting

Use a rotary cutter and ruler to cut the size and number of squares, rectangles and templates from each fabric listed below.

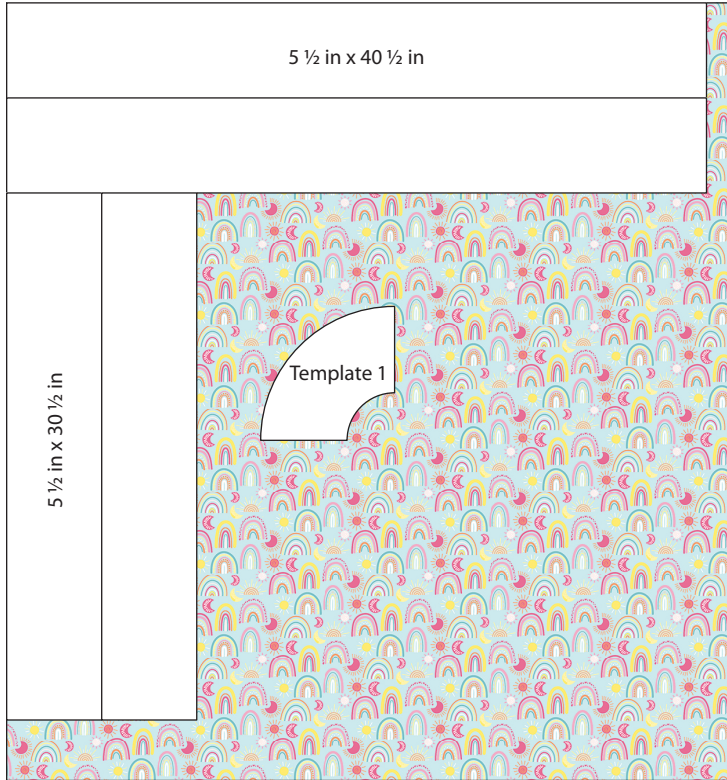

Rainbows and Sunshine – 19191-TRQ-FLN-D
1 ¼ yds x wof (114.3 cm x 106.68 cm)
 Cut 2 – 5 ½ in x 40 ½ in (13.97 cm x 102.87 cm)
 Cut 2 – 5 ½ in x 30 ½ in (13.97 cm x 77.47 cm)
 Cut 1 – Template 1

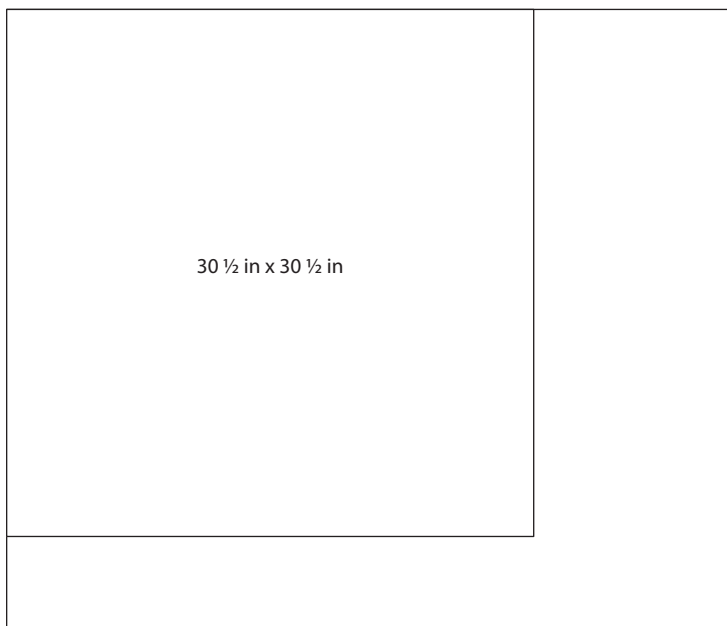

Solid White – 1 yd x wof (91.44 cm x 106.68 cm)
 Cut 1 – 30 ½ in x 30 ½ in (77.47 cm x 77.47 cm)

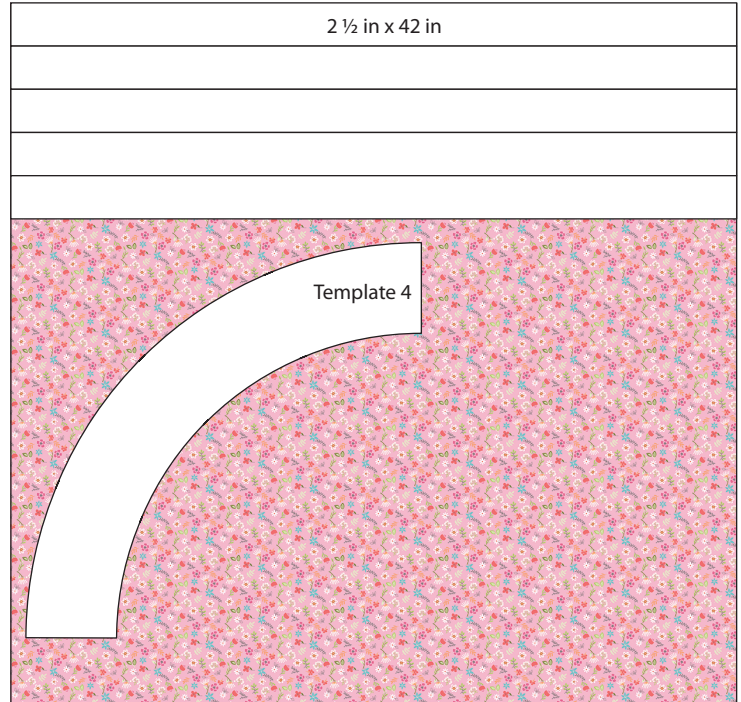

Flower Garden – 19192-PNK-FLN-D
1 ⅝ yds x wof (102.87 cm x 106.68 cm)
 Cut 5 – 2 ½ in x 42 in (6.35 cm x 106.68 cm)
 Cut 1 – Template 4

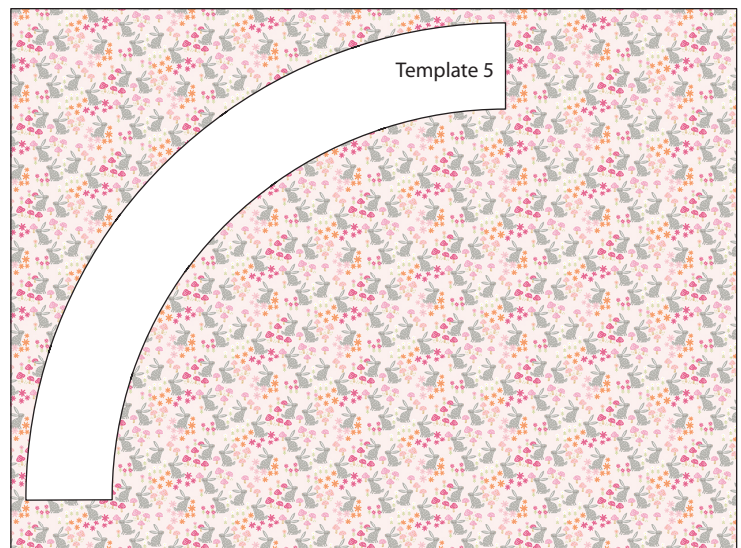

Bunny Field – 19192-PNK-FLN-D
7/8 yd x wof (80.01 cm x 106.68 cm)
 Cut 1 – Template 5

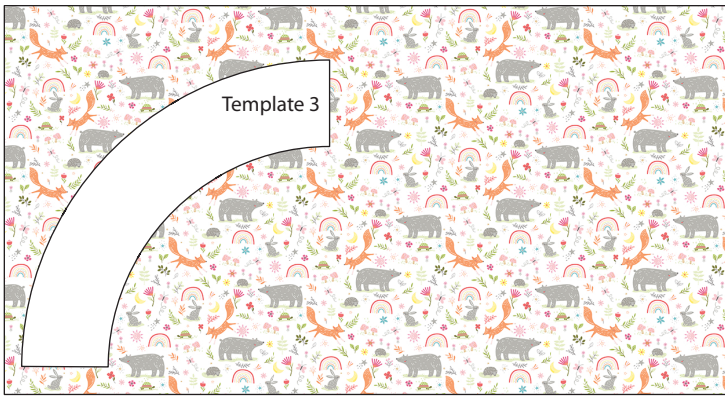

Friends Forest – 19190-WHT-FLN-D 5/8 yd x wof (57.15 cm x 106.68 cm)
Cut 1 – Template 3

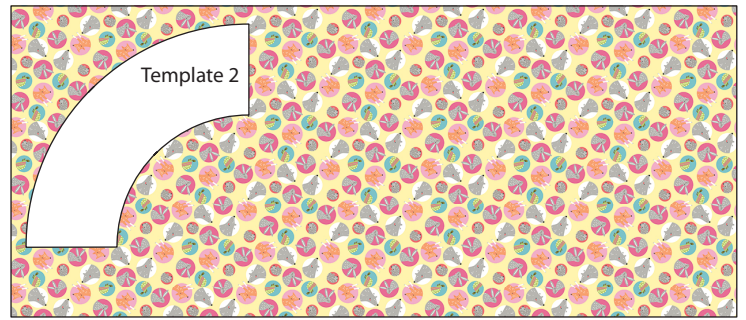

Circle Faces – 19194-YLW-FLN-D 1/2 yd x wof (45.72 cm x 106.68 cm)
Cut 1 – Template 2

Sewing

1. Tape the template sheets together.
2. Refer to Diagram A and follow the manufacturer's instructions to trace each template onto the paper side of the fusible web. **Note:** Template 2 and Template 4 have 1/8 in (3.18 mm) addition added to each long side so the pieces can be overlapped during assembly.

Dia. A

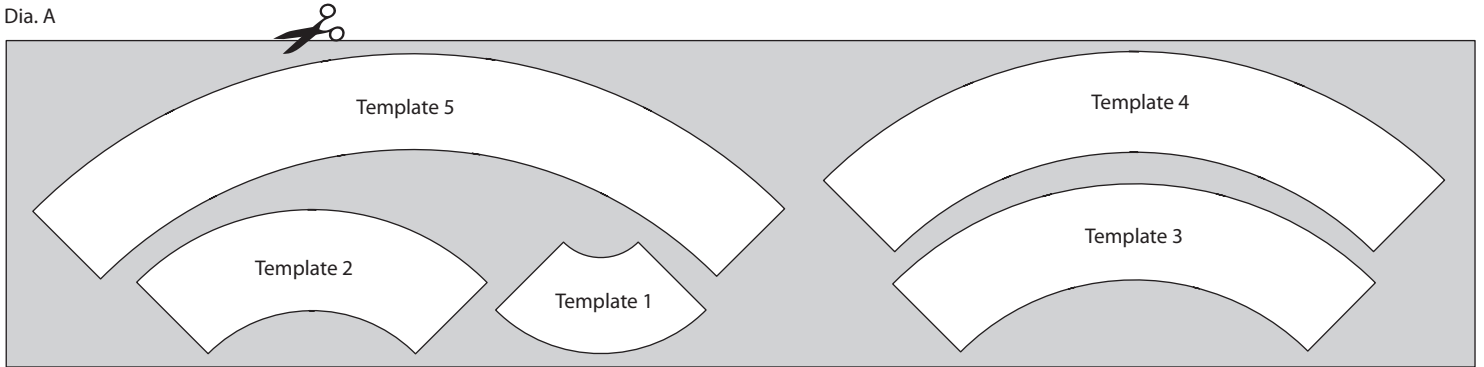

3. Refer to Diagram B to roughly cut out each fusible template outside the drawn line about 1/4 in (6.35 mm).

Dia. B

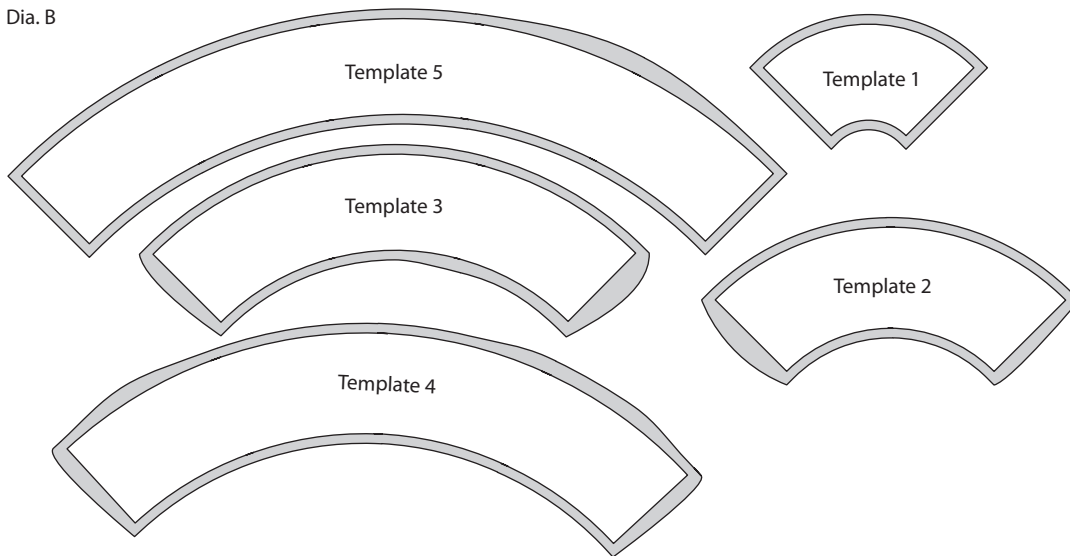

4. Refer to the Cutting List and Diagram C to press each fusible template onto the **wrong** side of the listed fabrics following the manufacturer's instructions. Cut out each template on the drawn line.

Dia. C

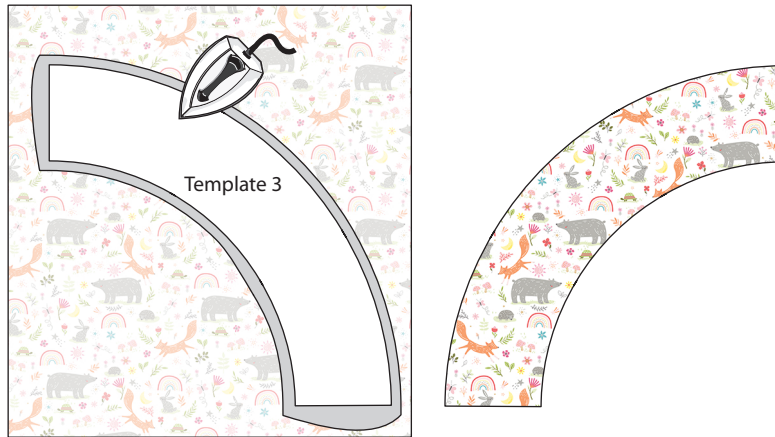

5. Refer to Diagram D to position Circle Faces - Template 2 piece on the lower right corner of the White 30 1/2 in x 30 1/2 in (77.47 cm x 77.47 cm) square. Align the short edges of the Circle Faces - Template 2 with the side and bottom edge of the White square. Press the piece in place. Repeat with the Flower Garden - Template 4 piece.

Dia. D

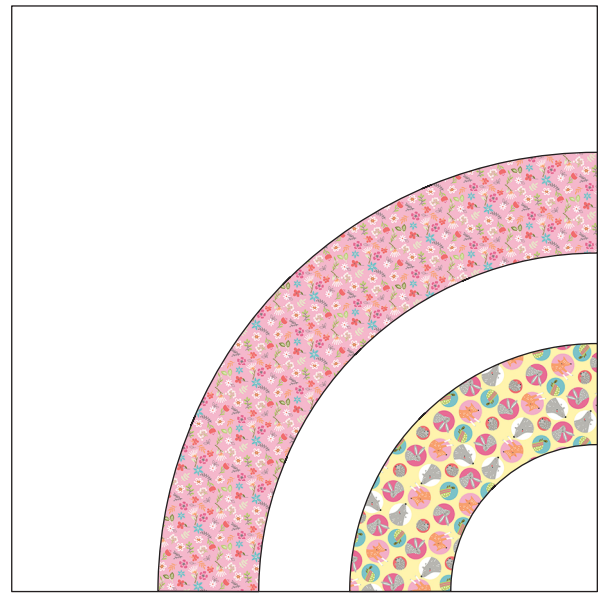

6. Refer to Diagram E to position the Friends Forest - Template 3 piece onto the White square, aligning the short ends of the template with the side and bottom of the White Square. The Friends Forest - Template 3 piece, should overlap Template 2 and Template 4. Press in place.

Dia. E

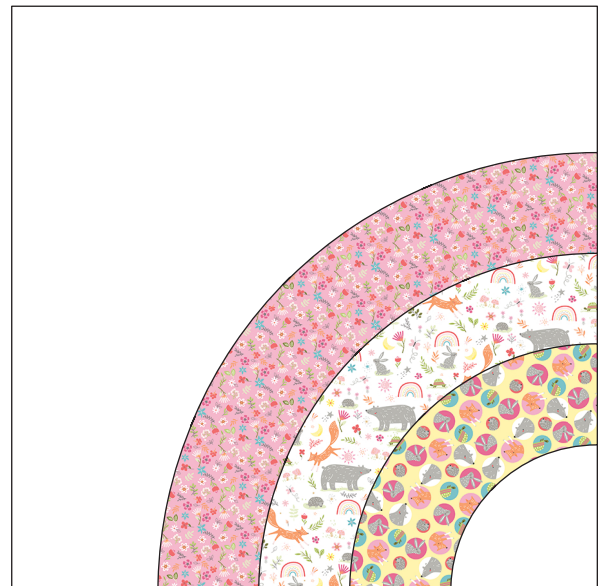

7. Refer to Diagram F to position and press the Bunny Field - Template 5 piece and the Rainbows and Sunshine - Template 1 piece to the White square, aligning the short ends of the templates with the White square. Press in Place.
8. Finish the raw edges of each shape with a decorative stitch such as a buttonhole or satin stitch to complete the Quilt Center. The Quilt Center should measure $30\frac{1}{2}$ in x $30\frac{1}{2}$ in (77.47 cm x 77.47 cm).

Dia. F

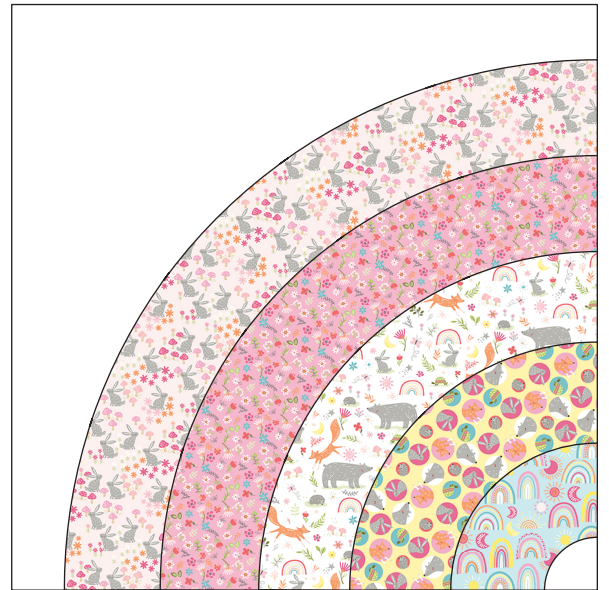

9. Refer to Diagram G to sew one Rainbows and Sunshine $5\frac{1}{2}$ in x $30\frac{1}{2}$ in (13.97 cm x 77.47 cm) RST to each side of the Quilt Center. Sew one Rainbows and Sunshine $5\frac{1}{2}$ in x $40\frac{1}{2}$ in (13.97 cm x 102.87 cm) RST to the top and bottom of the quilt center. The completed Quilt Top should measure $40\frac{1}{2}$ in x $40\frac{1}{2}$ in (102.87 cm x 102.87 cm).

Dia. G

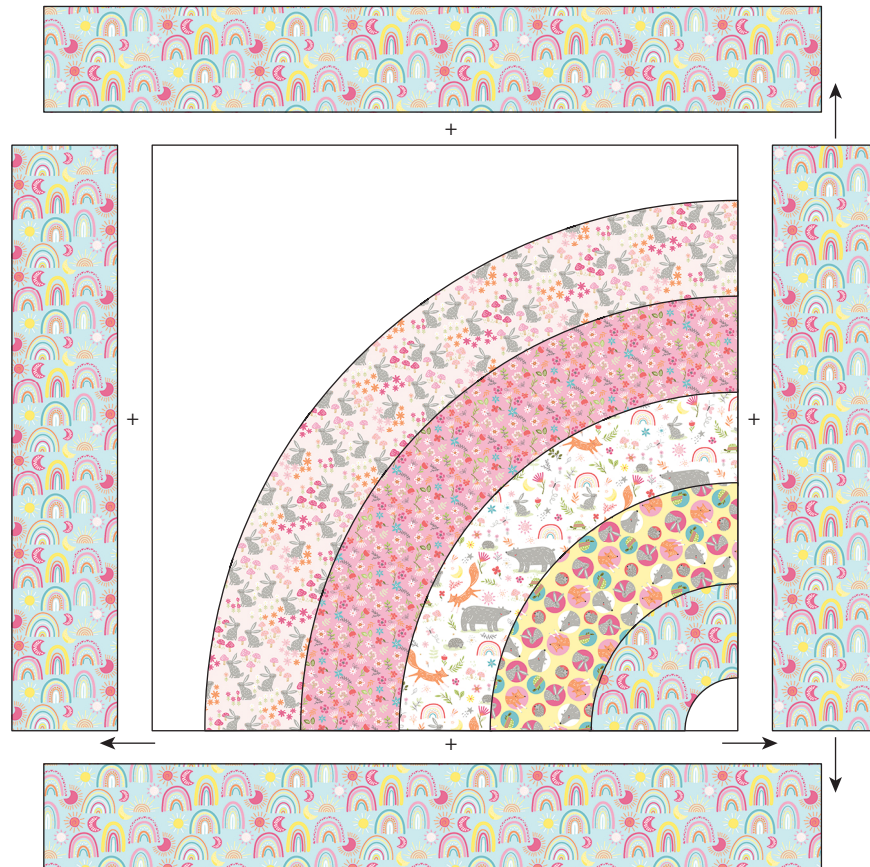

10. To make the Flower Garden Backing, remove the selvages and cut one piece 40 in x 48 in (102.24 cm x 121.92 cm) and two pieces 10 ¼ in x 24 ½ in (26.04 cm x 61.60 cm). Pin and sew the pieces RST along the long edges as shown in Diagram H. Trim the Back to measure 48 in x 48 in (121.92 cm x 121.92 cm).

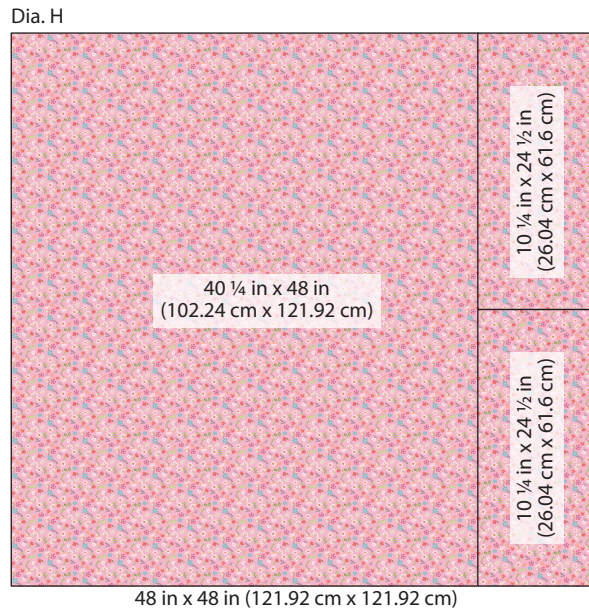

11. Press finished Quilt Top and Backing fabric. Tape the Backing **wrong** side up on a firm surface. Layer Batting and Quilt Top (right side up). Baste the layers together with safety pins. Quilt as desired.
12. Once the quilting is complete, square up corners and edges, trimming excess Backing and Batting even with the Quilt Top.
13. To make the Flower Garden Binding, remove the selvages and sew the short ends of the five 2 ½ in x 42 in (6.35 cm x 106.68 cm) strips RST end to end at a 45 degree angle to make one continuous strip; press seams open. Press one short end ¼ in (6.35 mm) to the **wrong** side. Fold in half lengthwise with **wrong** sides together; press. Leaving a 2 in (5.08cm) tail on the folded end, place cut edges of folded Binding even with the edge of the Quilt and sew, mitering the corners (Dia. I). Overlap ends, trim any excess and finish sewing the Binding. Fold the Binding over to the back and hand stitch.

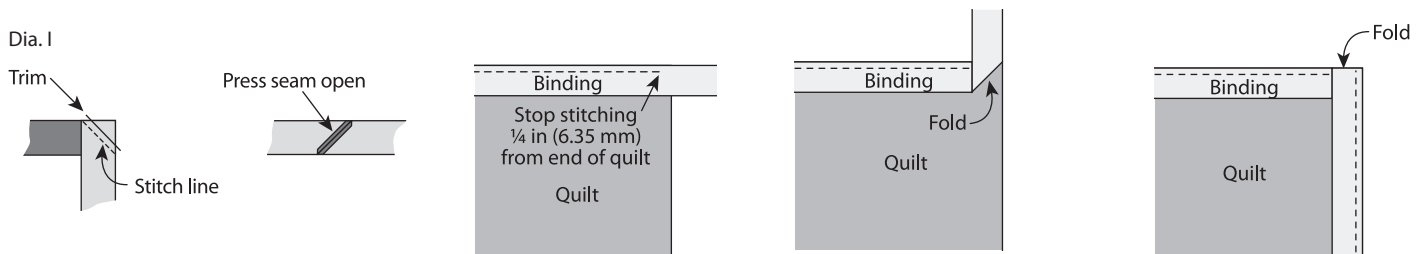

Finished Care Instructions

Machine wash in cold water; gentle cycle. Do not bleach. **Tip:** Before drying, check for fabric dyes that may have run. If fabric dyes run, rewash and rinse using a color catcher to absorb loose dye. Lay flat to dry or tumble dry low.

Rainbow Appliqué Template 1 (100% Scale)

Trace 1. Follow the instructions to trace, cut and fuse the template to fabric.

Scale:
1 square =
1 in x 1 in

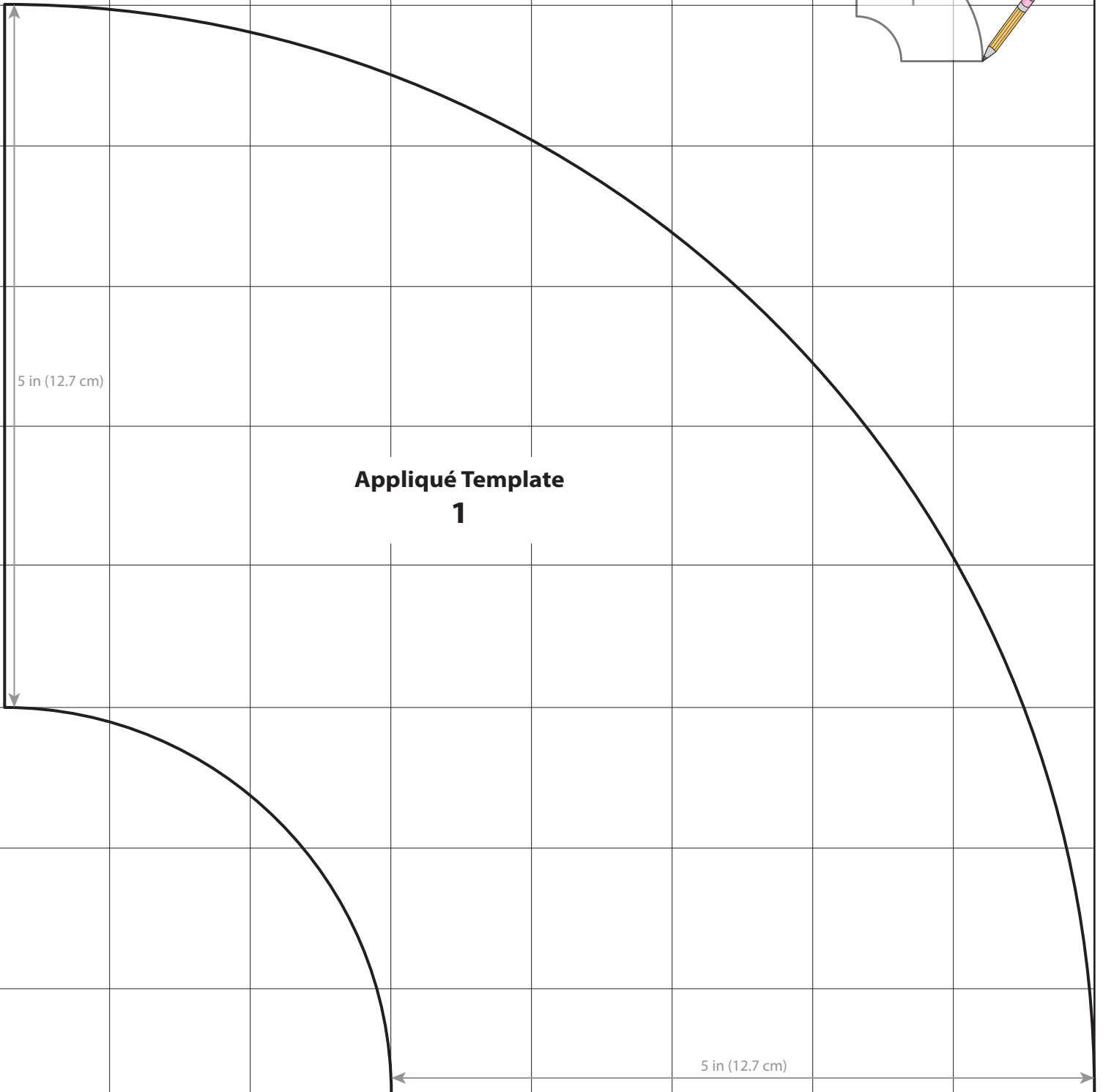

Rainbow Appliqué Template 2 (100% Scale)

Trace 2 times to make a band, aligning the top edge with the dashed line of the previous traced Template 2.
Then follow the instructions to trace, cut and fuse the template to fabric.

Scale:
1 square =
1 in x 1 in

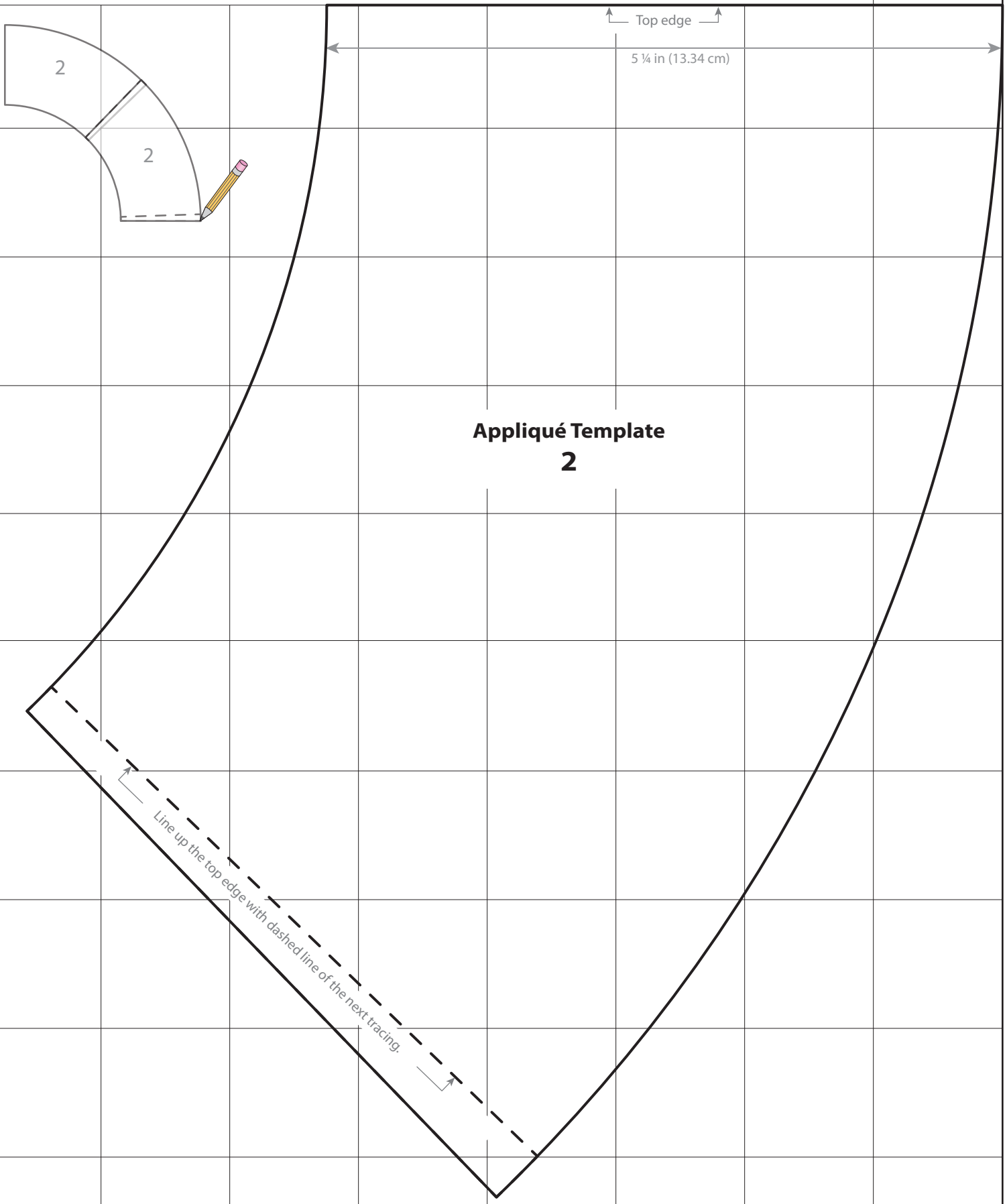

Top edge

5 1/4 in (13.34 cm)

Appliqué Template
2

Line up the top edge with dashed line of the next tracing.

Rainbow Appliqué Template 3 (100% Scale)

Trace 3 times to make a band, aligning the top edge with the dashed line of the previous traced Template 3. Then follow the instructions to trace, cut and fuse the template to fabric.

Scale:
1 square =
1 in x 1 in

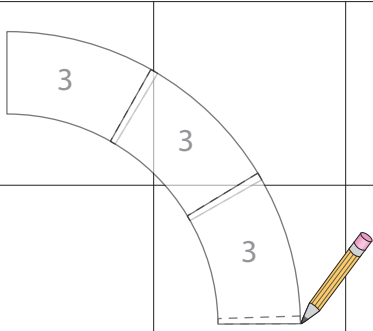

Top edge
5 in (12.7 cm)

**Appliqué Template
3**

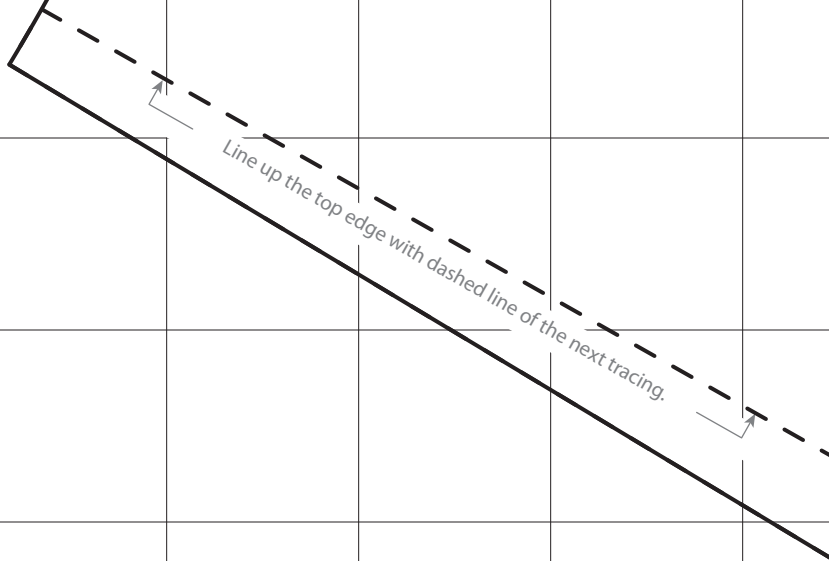

Rainbow Appliqué Template 4 (100% Scale)

Trace 4 times to make a band, aligning the top edge with the dashed line of the previous traced Template 4. Then follow the instructions to trace, cut and fuse the template to fabric.

Scale:
1 square =
1 in x 1 in

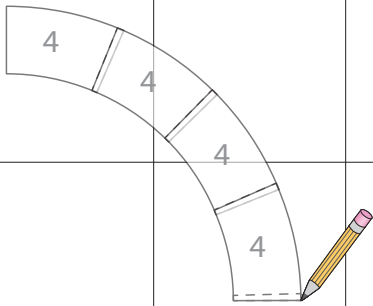

↑ Top edge ↓

5 ¼ in (13.34 cm)

**Appliqué Template
4**

Line up the top edge with dashed line of the next tracing.

Rainbow Appliqué Template 5 (100% Scale)

Trace 5 times to make a band, aligning the top edge with the dashed line of the previous traced Template 5. Then follow the instructions to trace, cut and fuse the template to fabric.

Scale:
1 square =
1 in x 1 in

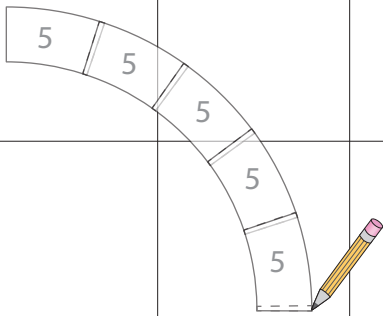

Top edge

5 in (12.7 cm)

**Appliqué Template
5**

Line up the top edge with dashed line of the next tracing.

